

TR-218 Datasheet

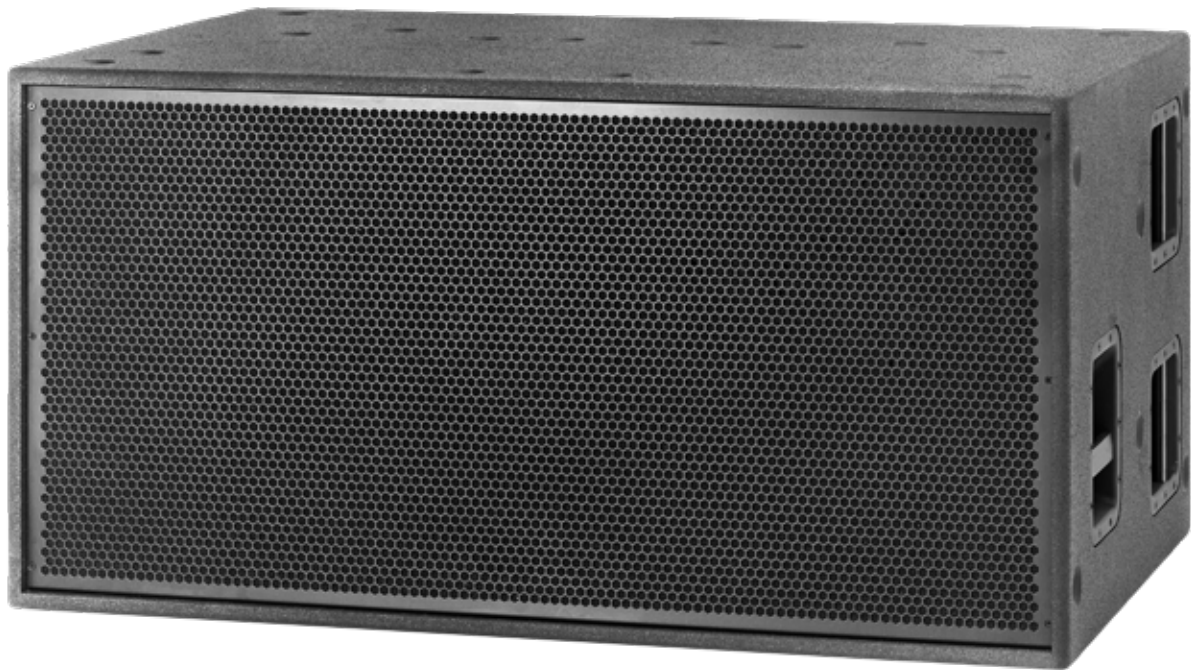

TR-218 is a high power, 28 Hz capable subwoofer designed for large venues and outdoor events. TR-218 can be used singularly or in multiples in both horizontal and vertical orientation using Omega's TR stacking system which ensures secure stacking of multiple units. Ground stacking is also possible with TR-212 Point source, V-ela and Kora line array systems

Using two of our proprietary 18" cast aluminium chassis drivers coupled with a hybrid horn/reflex design, this cabinet has a frequency response of 28 Hz to 179 Hz (-10 dB) at an astounding 140 dB SPL (peak).

The robust enclosure has a HEX design front grill, hardwearing Polyurea paint finish and three bar handles on each side. Integrated rubber feet are located on underside of the enclosure for securing in multiple ground stack positions on additional TR-218 subwoofers. Cups are countersunk into the top of the enclosure to lock in additional TR-218, TR-212.

Available separately is a TR-218 dolly-board enabling easy, single person movement between venues.

The rear cast aluminium connection plate has two 4 pin speakON® connectors fitted as standard, one input and one link. The speakON® connectors are wired on pins +1-1, with pass through of pins +2-2..

Key Features:

- Rebated Baltic Birch Plywood construction
- Tough Polyurea coating
- Reticulated weatherproof foam covered powder-coated Zintec steel grills
- Dual layer thermal relief driver technology
- TR Interlocking stacking system
- Heavy duty recessed steel handles

Technical Specifications

Design

2 x 18" Subwoofer, Multi-loaded Reflex/ Horn Advantaged Subwoofer.

Impedance

4 Ohm, Minimum 3.3 @ 35 Hz

Power Handling (AES)

1250 Watts (continuous)

Max. Power Handling (AES)

2500 Watts (program)

5000 Watts (peak 10 ms)

Sensitivity 2.83V / 1m

104 dB

Max. SPL

134 dB cont

140 dB peak

Frequency Response (± 3 dB)

32 Hz - 159 Hz

Usable Frequency Range (-10 dB)

28 Hz - 179 Hz

Dispersion

Omni

SYSTEM OPERATION

Recommended Amplification

1200 - 2000 Watts

System Controller

Omega DSP Solutions

Speaker Cables

Min - 2 x 4 mm²

Preferred - 2 x 6 mm²

PRODUCT FEATURES

Components

2 x 18" Low Frequency Driver

Crossover

Passive - -

Active - * LPF - 110 Hz

HPF - 29 Hz

Connectors

2 x 4 pole speakON® connectors

Dimensions (H x W x D mm)

584.3 x 1156 x 746

Weight (kg)

88

Shipping Weight (kg)

91 (1 cabinet per carton)

Colour

Black

Options

Available in white or RAL colours on request

Rigging

Foot and cup stacking system

HARDWARE

Fitted as Standard

Foot and cups stacking System, castor wheels, large bar handle.

Optional

TR-218 dolly board.

Additional Descriptive Data

Birch plywood construction, with durable scratch resistant black polyurea textured paint finish, kick-proof steel grill and internal black foam with Omega logo.

Recommended filter settings are available on the website omegaproaudio.co.uk/downloads

* All presets from the Omega library.

TR-118 Measurements

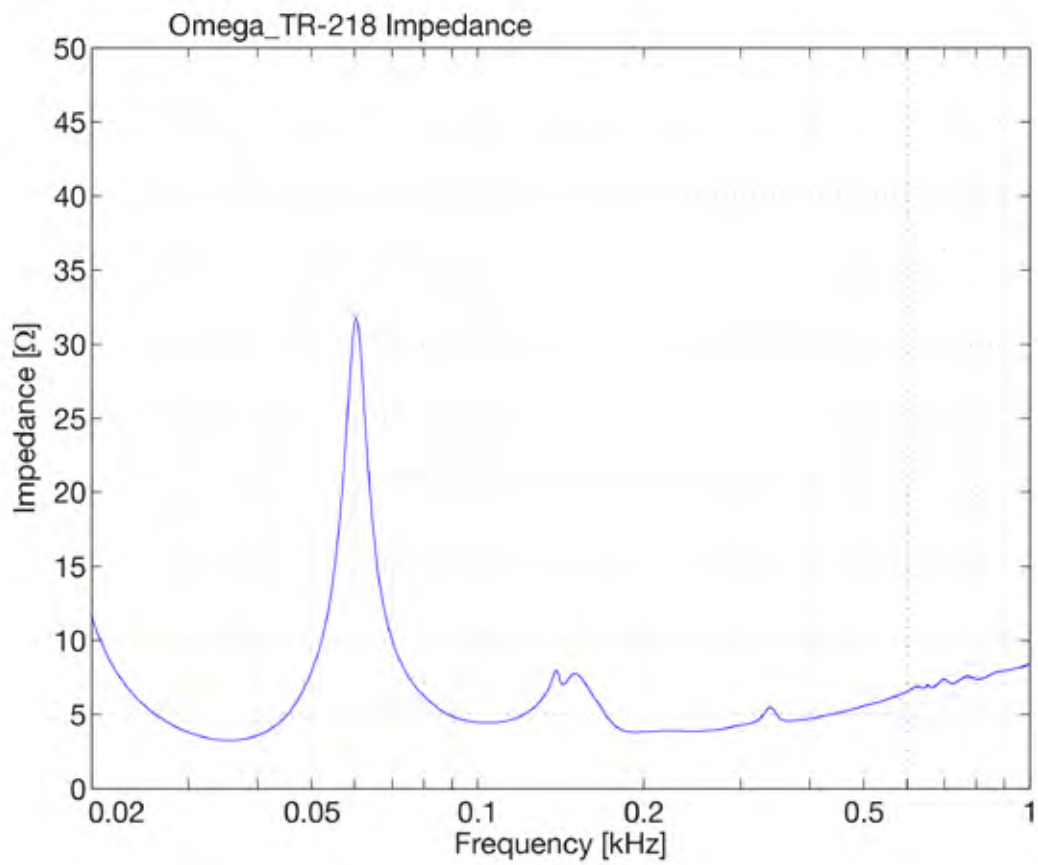
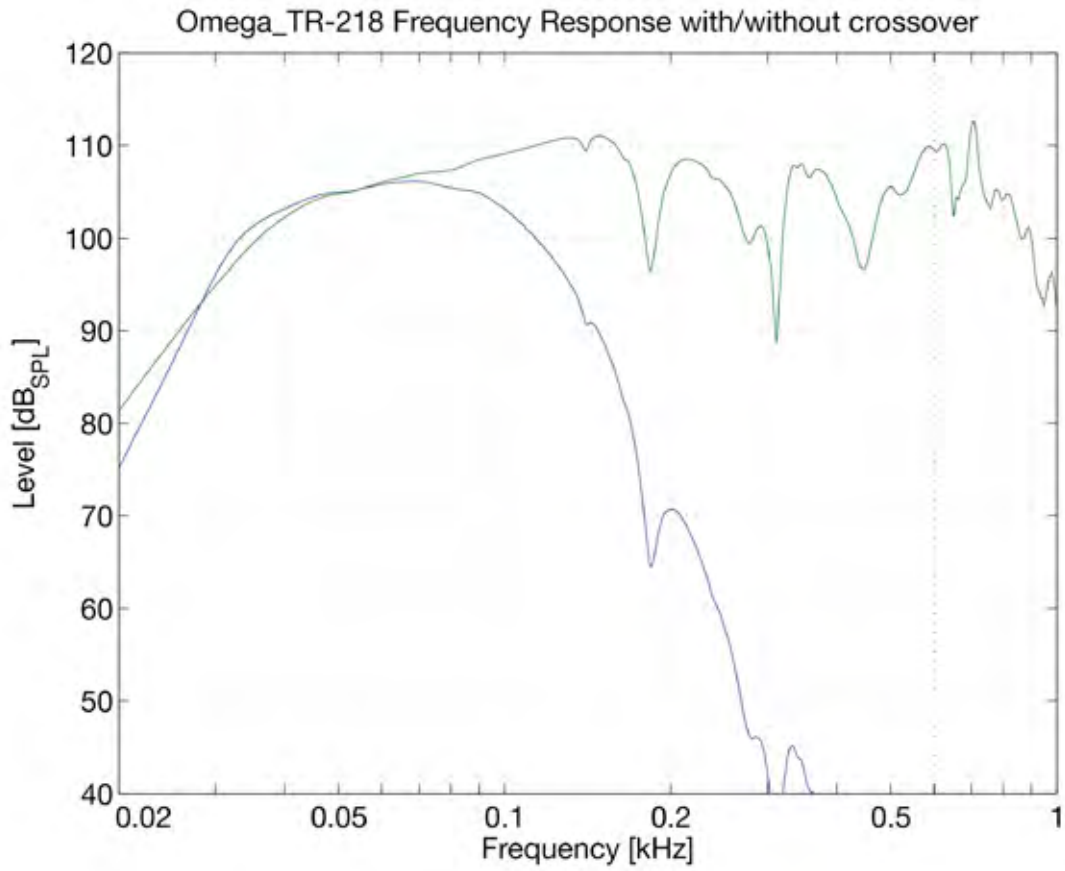

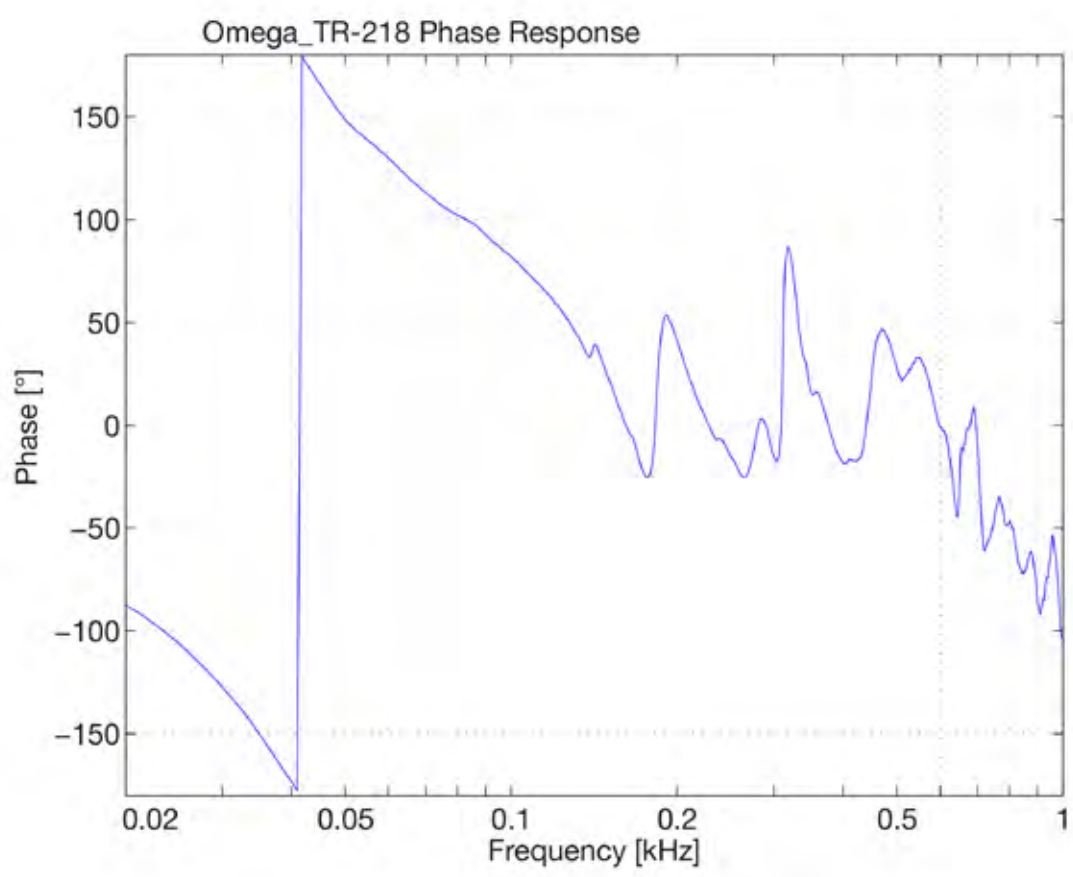
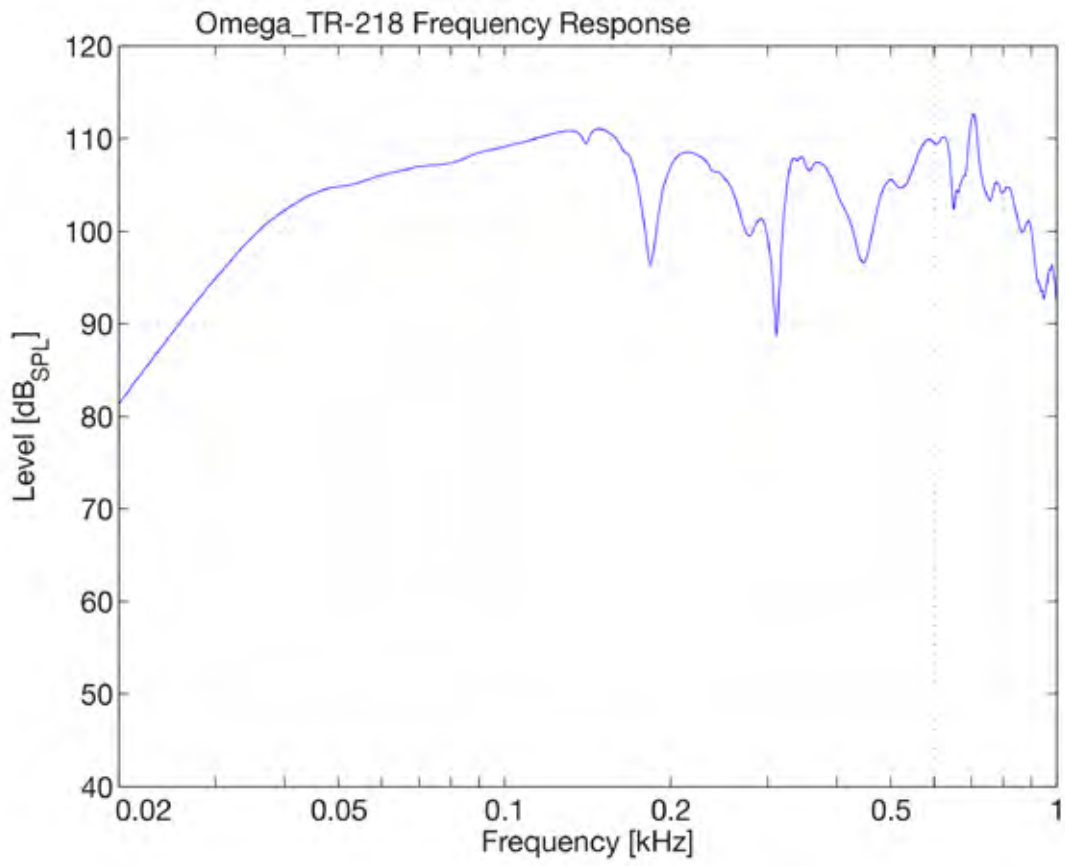

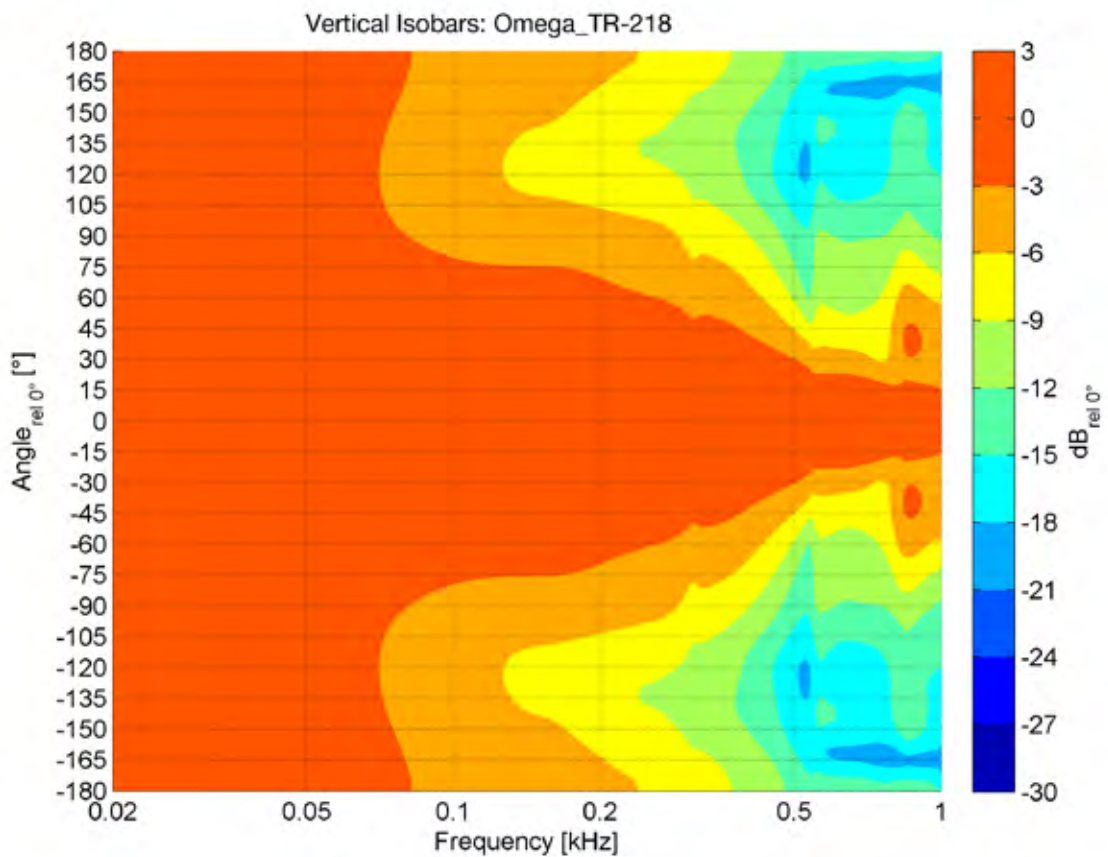
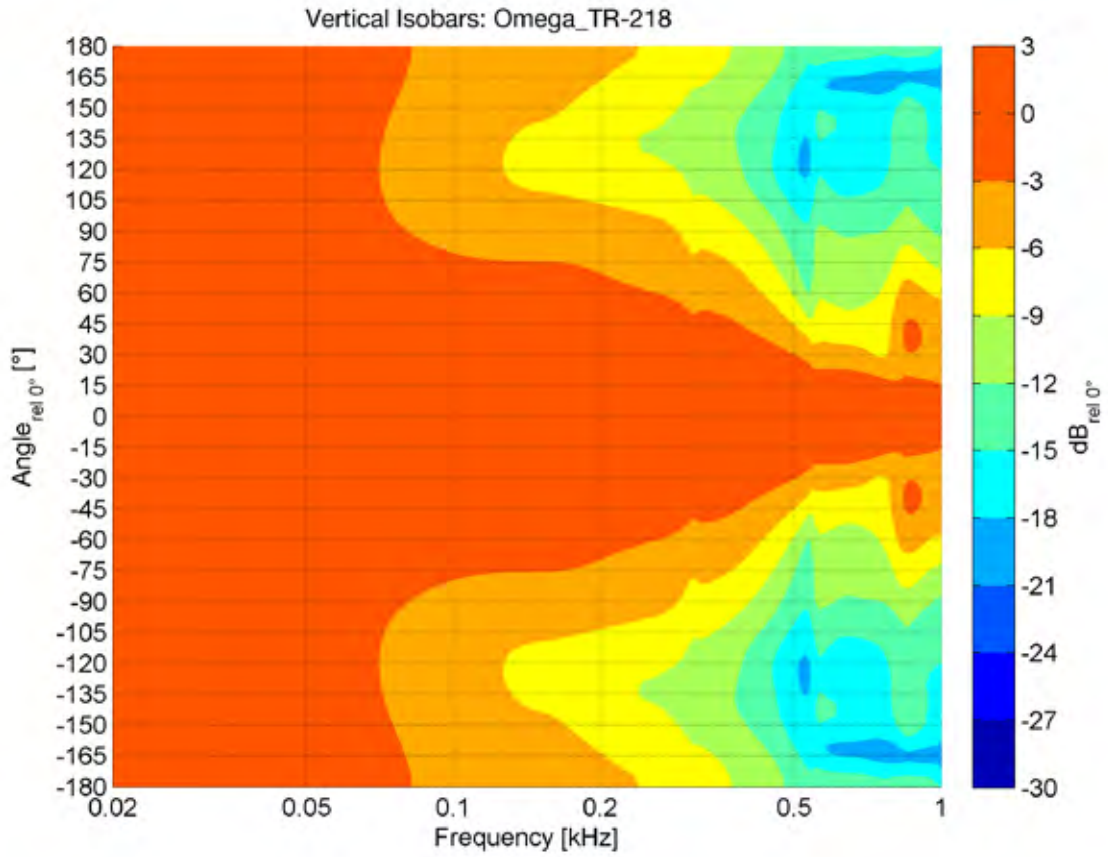

All Measurements are executed by the IFAA Institute for Acoustics in Aachen, Germany
measurement conditions 4PI environment for full range cabinets, 2Pi environment for subwoofers.

TR-218 Dimensions

Front

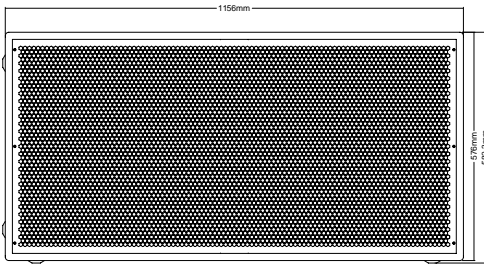

Side

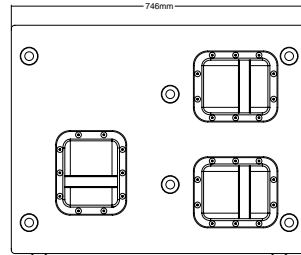

Back

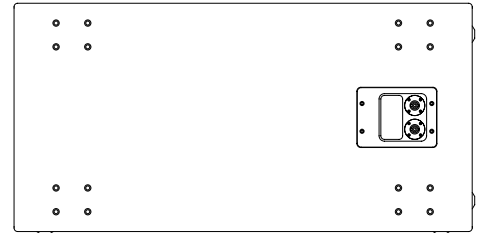

Bottom

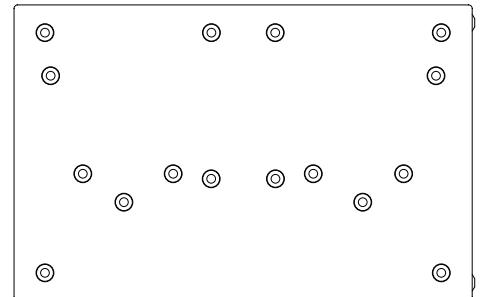

Top

Further technical drawings for architectural requirements are available in DXF and DWG format for download on the website.

TR-218 3D View

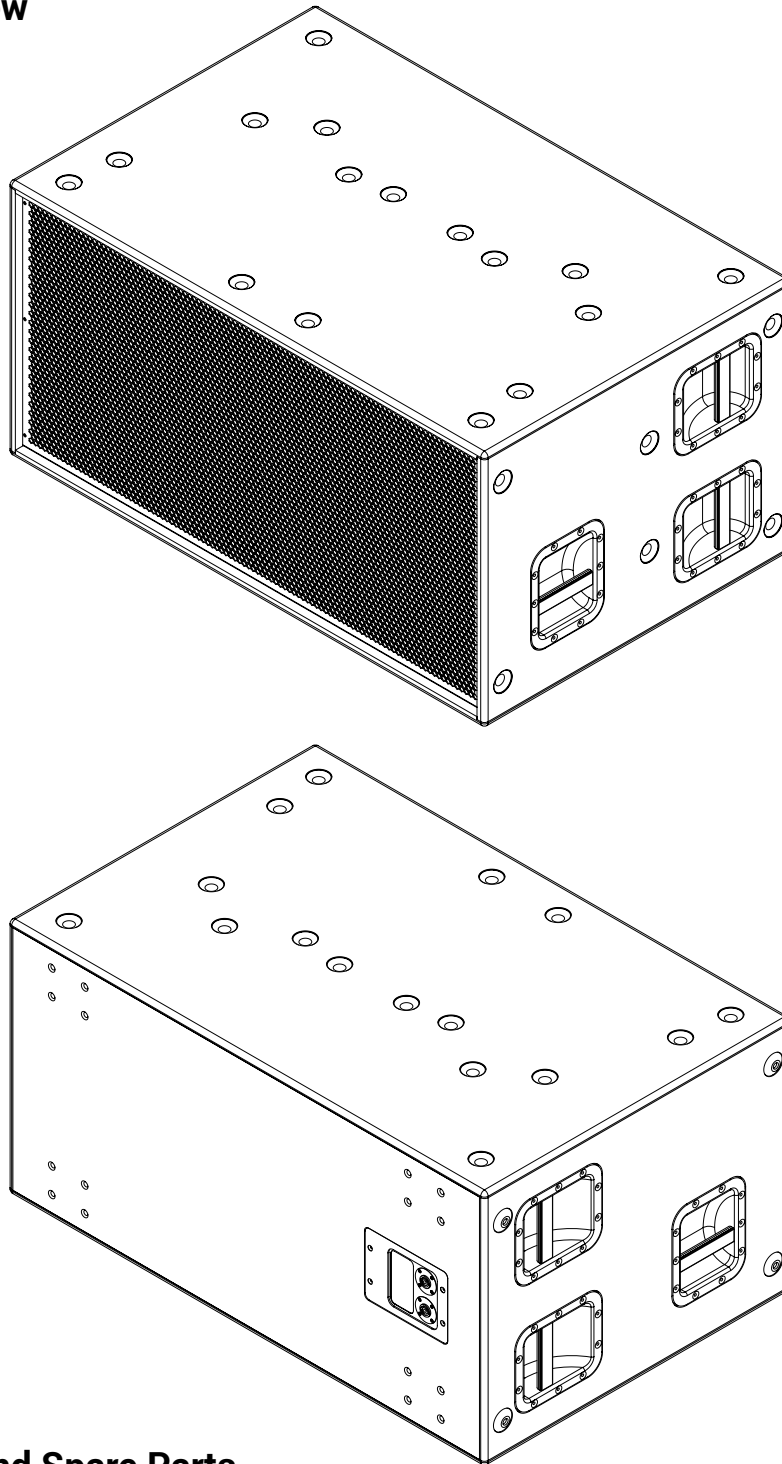

Accessories and Spare Parts

- Stacking foot and cup system
- 2 x 18" low frequency driver
- TR-218 steel grill assembly
- Large bar handles
- TR-218 backplate
- ST-CP castor pack
- TR-218 dolly board

Architects' & Engineers' specifications:

Multi-loaded Reflex/ Horn Advantaged Subwoofer design, housing 2 x 18" proprietary low bass driver. Homogeneous radiating behaviour and linear response in the entire frequency range. Constructed from different multi-laminated wood, eco-friendly scratch resistant paint, Foot and cup stacking system to ensure cabinets stability when stacked in multiples, ergonomic carry handles, kick proof steel grill finished with internal reticulated foam and Omega logo.

Technical Data:

Frequency Response: 28 Hz - 179 Hz (-10dB), 32 Hz - 159 Hz (± 3 dB), Continuous SPL: 134 dB/1m, Program SPL 137 dB/1m, Peak 140 dB/1 m. Power Handling: 1250 Watt cont. IEC268 AES, Maximum Power Handling: 2500 Watt prog. / 5000 Watt peak, Impedance Nominal: 4 ohm, Dispersion Nominal: Omni (hor. x vert.), Connectors: 2 x speakON® connectors NL4MP (1+/1-, 2+/2- links). Dimensions (H x W x D): 584.3 mm x 1156 mm x 746 mm, Weight: 88 kg. Options: Durable scratch resistant black textured paint finish. RAL colours available to order.

Safety Instructions

Professional speaker systems are able to produce sound pressure levels that could harm your health.

Never stand directly in front of loudspeakers for long periods. Whilst not immediately apparent to the listener, sound pressure levels in excess of 90dB@1m can be hazardous to the hearing.

Please refer to the following advice when setting up or dismantling OMEGA speaker systems.

1. Be sure to leave adequate distance between speakers and the public. Refer to your local authority for Health and Safety guidance when using loudspeaker systems.
2. Be sure to have safe and stable ground for your speakers, particularly when using speaker stands.
3. When stacking speaker systems, ensure they are secured to prevent individual speakers from falling down or moving around.
4. Only use OMEGA mounting hardware, as this has been specified and approved by KHZ LTD, for use with OMEGA speakers.
5. When flying speakers, appropriate materials and techniques must be employed in order to safely suspend enclosures, taking care to allow for specified enclosure weight.
6. Please observe any special instructions that appear on specific loudspeaker data-sheets.
7. Check your speaker hardware and flying material regularly for any visual or mechanical

Safety Instructions Cont.

failure. Replace damaged or suspect items when necessary.

8. Only use OMEGA DSP Solutions. Only technicians authorised by KHZ LTD are qualified to program digital controllers. Take note of recommended controllers as specified on the datasheets. Do not use OMEGA loudspeaker systems without the correct controller. If a system fails due to incorrect controller use, warranty is void.

9. Protect your speakers and electronics from freezing and do not expose them to humidity, water or rain without protection.

OMEGA loudspeakers and electronics are covered against defects in workmanship or materials for a period of two (2) years from original date of purchase. At the discretion of KHZ LTD, the defective item will be repaired/replaced with no charge for materials or labour. The item is to be adequately packed and dispatched, pre-paid, to an OMEGA authorised distributor/service centre. Unauthorised repair shall void the warranty. The OMEGA warranty does not cover cosmetics or finish and does not apply to any item which in OMEGA's opinion has failed due to user abuse, accident, modifications or any type of misuse.

Disclaimer

Copyright © 2022 KHZ LTD

The content of this datasheet is protected by U.K. and foreign copyright law and is for the private use of users of OMEGA products. Unauthorised use of the contents of this datasheet may violate copyright, trademark and other laws.

THE CONTENT OF THIS DATASHEET IS PROVIDED FOR INFORMATIONAL PURPOSES ONLY, AND IS SUBJECT TO CHANGE WITHOUT NOTICE.

KHZ LTD MAKES NO REPRESENTATION ABOUT ACCURACY, RELIABILITY OR TIME-LINES OF THE CONTENT OF THIS DATASHEET OR THE RESULTS TO BE OBTAINED FROM USING ANY PART OF SUCH CONTENT. ALL WARRANTIES, EXPRESS OR IMPLIED RELATED TO SUCH CONTENT, INCLUDING THE WARRANTY OF MERCHANT AND FITNESS FOR A PARTICULAR PURPOSE, ARE DISCLAIMED.

Technical specifications, dimensions, weights and properties do not represent guaranteed qualities. This datasheet does not include all of the details of design, production or variations of the equipment.

G.S.S.S.[™], S.A.L.T.[™] Plate Array Skeleton[™], Zero Acoustic Signature, Technology[™] and H.T.V.C.[™] are trademarks of KHZ LTD. All third-party trademarks mentioned herein are the property of their respective owners.