

# USER MANUAL

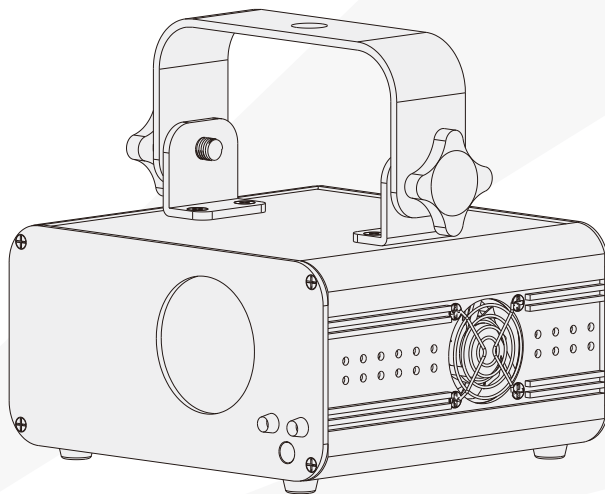

Version 1.0



# Unpacking Instructions

---

## Read Manual before Operation

Dear user,  
Thanks for choosing our laser device, believing this brand new product will bring you unlimited marvel and happiness. Before operating this device, please read this manual thoroughly, and retain it for future reference.

## Warning Data

Please note the warnings in bold which will ensure the safe and smooth operation. These warnings are important to a certain extent.



**Attention!** Indicates a skill or other useful information for special situations.



**Important!** Indicates important information to protect personnel from laser incident or injury.



**Caution!** Prevent damage or injury from incorrect operation.



**Laser!** Laser safety warning labels.

### Warning!

If the external flexible cable or cord of this luminaire is damaged, it shall be replaced by a special cord or cord exclusively available from the manufacturer or his service agent.

Shields, lenses or ultraviolet screens shall be changed if they have become visibly damaged to such an extent that their effectiveness is impaired, for example by cracks or deep scratches.

The lamps shall be changed if it has become damaged or thermally deformed.

## Unpacking Instructions

As receiving a fixture, carefully unpack the carton, checking contents to ensure that all parts are in good condition. Informing the shipper immediately and retaining packing material for inspection if any parts damaged from shipping or device damaged. Keep packing materials as evidence for shipper's confirmation.







**Attention!**

This unit is in perfect condition before delivery; please check all accessories when unpacking the unit. User should follow this user manual to operate this unit, and make sure that you are clear on all laser safety information and unit operation before power it on. Any wrong operation will make this unit out of warranty.





NAME	QTY
Laser Light	1 PCS
KEYs (for key switch)	2 PCS
Power Cord	1 PCS
Interlock Connector	1 PCS

# Safety Instructions

## Safety Instructions

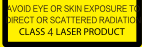
-  To protect the environment, please try to recycle the packing material as much as possible.
-  The projector is for indoor use only, IP20. Use only in dry locations. Keep this device away from rain and moisture, excessive heat, humidity and dust. Do not allow contact with water or any other fluids, or metallic objects
-  Don't throw this product away just as general trash, please deal with the product follow the abandon electronic product regulation in your country.
-  Locate the fixture in a well ventilated spot, away from any flammable materials and/or liquids. The fixture must be fixed at least 50cm from surrounding walls
  - ◆ To avoid condensation to be formed inside, allow this unit to adapt to the surrounding temperatures when bringing it into a warm room after transport.
  - ◆ Condense sometimes prevents the unit from working at full performance or may even cause damages.
  - ◆ Don't install it on flammable object.
  - ◆ Don not use it when maximum ambient temperature is higher than 40 degree,
  - ◆ Unplug the unit when it is not used for a longer time or before replacing the bulb.
  - ◆ Don't open the top cover to avoid unit damage.
  - ◆ Please use the original packing when the device is to be transported.

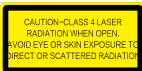
## Laser Safety Warnings

-  According to EN 60825-1:2007, this product belongs to class 3B. Direct eye contact may cause injury.
- ◆ This product is for laser show only. The class 3B laser light should be operated by professional operator only.
- ◆ This is so-called show laser, emitting radiation with a wavelength spectrum between 400 and 700nm and producing lighting effects for shows.
- ◆ International laser safety regulations require that the vertical height from installment to ground is more than 3 meters, horizontal distance is 2.5 meters from audience.
- ◆ Never direct the laser beam to people or animals and never leave this device running unattended.
- ◆ The legal requirements for using laser entertainment products vary from country to country. The user is responsible for the legal requirements at the location/country of use.
-  **Warning!** Avoid direct eye contact with laser beams during operation, especially when the laser beams stay still, or injury to eyes may occur.

### Laser Safety Protection Feature

-  **Caution!**The laser security measures are designed according to the specific terms of the relevant international laser safety standards and has the following laser safety protection means.
  - Laser key switch: laser is available only when the key is turned on.
  - Laser Emergency switch: remote connecting switch,it will cut off the laser light path emergently once the device in potential hazard;
  - Laser indication : laser indication on the front panel of the laser light for indicating " laser-ready ".
  - Laser safety label: The labels of according with European standard are stucked on the device body.

# Overhead Rigging

 Attention! The installation must be carried out by qualified service personal only. Improper installation can result in serious injuries and /or damage to property. Overhead rigging required extensive experience! Working load limits should be respected, Certified installation materials should be used, the installed device should be inspected regularly for safety.

- ◆ Make sure the area below the installation place is free from unwanted persons during rigging, de-rigging and servicing.
  - ◆ Locate the fixture in a well ventilated spot, far away from any flammable materials and/or liquids. The fixture must be fixed at least 50cm from surrounding walls
  - ◆ The device should be installed out of reach of people and outside areas where persons may walk by or be seated.
  - ◆ The device should be well fixed; a free swinging mounting is dangerous and may not be considered!
  - ◆ Do not cover any ventilation opening as this may result in overheating
- Before the first time use, it must be inspected by professional staff to make sure safety, inspection regularly every year.

 Before rigging make sure that installation area can hold the 10 times weight of device. Using the steel rope which can hold 12 times weight of device, through the eye-bolt for assisting hang

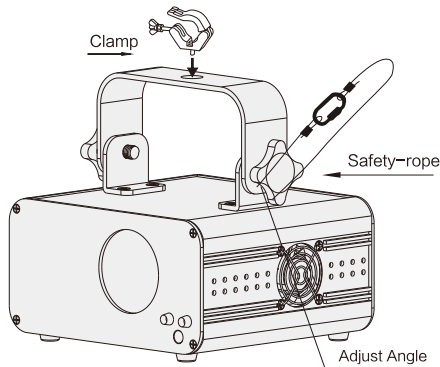

## AC Power

Please use the attached power, note that power voltage and frequency are the same as the marked voltage and frequency of device when connecting power. Every device' s power should be connected separately, so that device can be controlled individually.

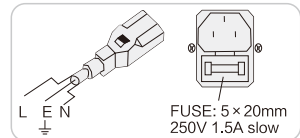

The power cord specification table:

Cable(EU)	Cable(US)	Pin	International
Brown	Black	Live	L
Liht blue	White	Neutral	N
Yellow/Green	Green	Earth	

# Overhead Rigging

## DMX connection

- ◆ Connection between laser lights and DMX must use the shielded cable of diameter more than 0.5mm. Please use the attached 3 pin XLR plug/socket to connect the DMX output/input interface. The connection between socket and cable as below( note the plug/socket's 3 pin number and position).

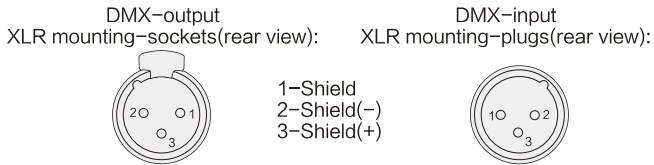

- ◆ Note, XLR plug/socket's 3pin can not be touched by inner hull, connection between pins is not allowed. Except above connection, XLR plug/socket can not be connected with XLR control line. Device receives international standard DMX512(1990) control signal.
- ◆ When using standard DMX512 control signal, the last device's output interface must be connected to a DMX plug. This plug is putting a 120 ohm resistance between "canon" plug's 2 pin and 3 pin. Showing as below pic. Sticking this plug into the last device's signal output interface, it will avoid the interference during the process of signal transmission.

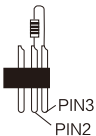

## Centring adjustment

Once transportation, DMX mistake etc, laser image may deviate from the center of lens. You can use the LED digital panel to adjust motor and ensure laser program in the center of lens. Easy operation and practical function.

Pressing the 4 buttons at the same time, turning on the device, entering the model of digital centring. FUNC button choose SHE to set X axis and SHY to Y axis, the "UP" and "DOWN" to set deviation size. Observing the place of image and light lens, moving it to the right centre of light lens, then pressing the "ENTER" to confirm and save.

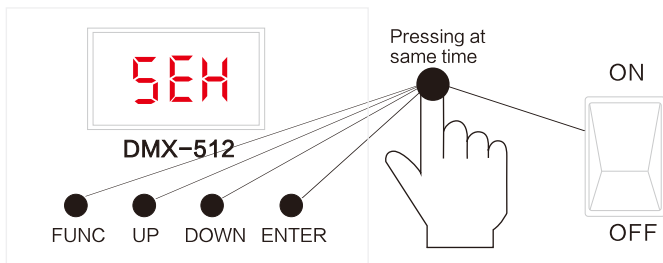

# Operation instructions

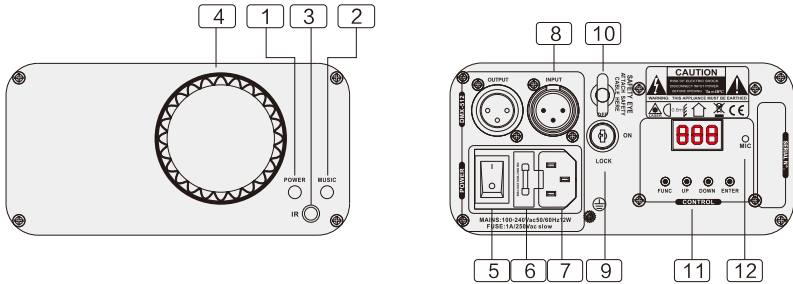

## Product operation diagram

No	Name	Function
1	POWER	Main power indicate LED. Red is ON.
2	MUSIC	Synchronize to detected music signal
3	IR	Infrared Remote Receiver
4	Laser output	Laser output aperture.
5	Switch	Switch on and off the power
6	Fuse Holder	A backup fuse inside
7	Mains input	With socket and integrated fuse holder
8	DMX output DMX input	3PIN Female XLR port, using for DMX 3PIN Male XLR port, using for DMX
9	Key switch	Make sure the professional person use
10	Safety eye	Connecting wire rope to prevent illegal operation and fall
11	LED control interface	Various mode setting operation for machine
12	Mic	Microphone. Turn the knob to adjust the sound activated sensitivity.

# Menu operating instruction

Once after every power on laser, the VERSION and MANUFACTURE INFORMATION will be shown in LCD monitor of rear panel. When laser is powered on, LCD monitor on rear panel shows the current operating standalone mode or DMX address of DMX mode. With help of LCD control panel, is very easy to set and change the operating mode of laser. After every resetting and saved, the new mode information will be shown on LCD monitor at next power on.

- FUNC** Mode Option, to choose the operating mode of laser.
- ENTER** Confirmation, to confirm the laser to show the present mode at the next operation.
- UP** **DOWN** UP/DOWN, to change operating mode, parameter or DMX address.

FIT-S(150R RE), FIT-S(50G RE), FIT-S(480B RE)  
 FITI-D(RG RE),FITI-D(GG RE),FITI-D(BB RE)

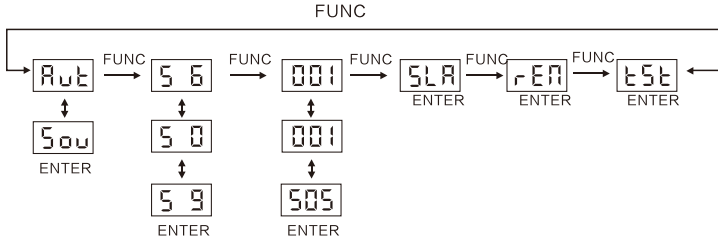

LED Display	Function
AUT	AUTO Show
SOU	SOUND Show

FIT-S(RGY RE), FIT-S(RBP RE), FIT-S(GBC RE)

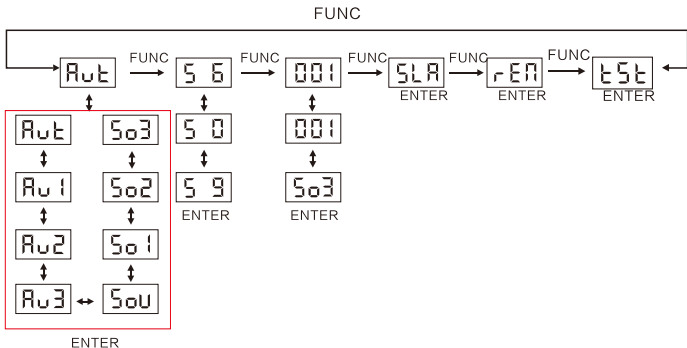

# Menu operating instruction

LED Display	Function
Aut	Auto
Au1	Aut 1
Au2	Aut 2
Au3	Aut 3
Sou	Sound
So1	Sou 1
So2	Sou 2
So3	Sou 3

 Attention : In preprogrammed standalone SOUND mode, the laser beam will be blank-out in 3 seconds without AUDIO/MIC activated signal.

## Initial setting

FUNC	UP DOWN	ENTER
Built-in Programs	AUT 5 shows Auto A3D 3D shows Auto AUB light beam show Auto AUL Lumia show Auto AUN AUTO show double bursting grating AUO Universe nebula show Auto SXX Above show with sound control	Press UP/DOWN to choose different effects, then press ENTER to confirm;
Sound Sensitivity	LED displayer will play S0-S9, S0 means receive no any sound; from S1 to S9, the sensitivity is stronger and stronger;	Press UP/DOWN to choose the sensitivity and press ENTER to confirm;
DMX Mode	DMX ADD 001 To DMX ADD 503	
Slave Mode	Confirm the laser in SLAVE MODE. Connect MASTER laser with several SLAVE laser with DMX cable, SLAVE lasers are doing exactly the same laser show as MASTER laser. Note: The slaves can't receive the remote signal;	If the words strobing always on the LED displayer, that means the DMX signal or the slave signal is not connected well, pls check the cables and the controller device.
REM Mode	In any standalone mode excepted SLA, pressing ON/OFF for 2 seconds to activate remote function, and will be return the original mode pressing ON/OFF for 2S again;	Choose UP/DOWN; press ENTER to confirm;



# Remote Controller

## Remote Controller

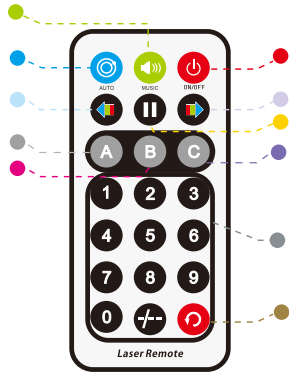

- AUTO Shows
- MUSIC Shows
- Laser NO/OFF
- Color Changing
- Effect Pause
- A / C Mirror Func
- SOUND Sensitivity
- Fixed Pattern(32)
- Repeat playing

Button	Function	Description
	ON/OFF	All modes other than the "slave" mode, continue to press "ON/OFF" in the remote control button for 2 seconds, you can enter or exit the remote mode.
	AUTO	AUTO Shows
	MUSIC	Music control mode, in this mode, if it receives sound signal, the blue LED will twinkling
	Sound Sensitivity	In the sound mode, press the "B" key in the remote control, then the panel below "1-9" correspond to the voice sensitivity setting, "9" is the most sensitive
	Color change	For multi-color products, each time you press the key, will change color.
	Picture change	Show pictures or change pictures
	Fixed pictures	Choose your favor pictures from 1 to 32
	Repeat playing	Repeat switching the current pattern and the last pattern

Note: In remote mode, all controls and settings are automatically saved until reboot, After the reboot, the first time into the remote control mode, the system will run self-propelled state.



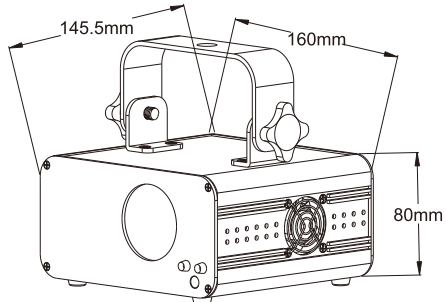

## Mess





# DMX instructions

## DMX Channels Chart

FIT-S(150R RE) FIT-S(50G RE) FIT-S(480B RE ) FIT-D(GG RE) FIT-D(BB RE)







Channel	Value	Fauction	
CH1 Mode	000-063	Laser OFF ①	
	064-127	AUTO	
	128-191	SOUND	
	192-255	DMX Model	
CH2 pattern	000-255	32 Laser Patterns	
CH3 Zooming	000-127	100%-5% fixed pattern zoomed	
	128-169	Zooming IN	
	170-209	Zooming OUT	
	210-255	Alternately Zooming	
CH4 Y axis rolling	000-127	0 -359 degree fixed Y axis rolled	
	128-191	Clockwise rolling	
	192-255	Anticlockwise rolling	
CH5 X axis rolling	000-127	0 -359 degree fixed X axis rolled	
	128-191	Clockwise rolling	
	192-255	Anticlockwise rolling	
CH6 Z axis rolling	000-127	0 -359 degree fixed Z axis rolled	
	128-191	Clockwise rolling	
	192-255	Anticlockwise rolling	
CH7 X axis mobile	000-127	128 different fixed position on X axis	
	128-191	Clockwise moving	
	192-255	Anticlockwise moving	
CH8 Y axis mobile	000-127	128 different fixed position on Y axis	
	128-191	Clockwise moving	
	192-255	Anticlockwise moving	

## FIT-D(RG RE)

Channel	Value	Fauction
CH9 Color	000-031	Original preprogramed color
	032-063	Red 
	064-095	Green 
	096-127	Red & Green 
	128-255	Color Rolling

































# DMX instructions

FIT-S(RGY RE) FIT-S(RBP RE) FIT-S(GBC RE)

Channel	Value	Fauction	
CH1 Mode	000-029	AUT	
	030-059	AUT 1	
	060-089	AUT 2	
	090-119	AUT 3	
	120-149	SOU	
	150-179	SOU 1	
	180-209	SOU 2	
	210-239	SOU 3	
	240-255	DMX Model	
CH2 Pattern	000-255	32 Laser Patterns	
CH3 Color	000-024	Laser OFF 	
	025-049	Original preprogramed color	
	050-074	Color effects 1	
	075-099	Color effects 2	
	100-124	Color effects 3	
	125-149	Color effects 1 To Color effects 2	
	150-174	Color effects 2 To Color effects 3	
	175-199	Color effects 1 To Color effects 3	
	200-224	Color effects 1 To Color effects 2 To Color effects 3	
	225-255	Color Rolling	
CH4 Color Roll Speed	000-004	NO rolling	
	005-255	Fast to slow	
CH5 Zooming	0-127	100%-5% fixed pattern zoomed	
	128-169	Zooming IN	
	170-209	Zooming OUT	
	210-255	Alternately Zooming	
CH6 Y axis rolling	000-127	0 -359 degree fixed Y axis rolled	
	128-191	Clockwise rolling	
	192-255	Anticlockwise rolling	
CH7 X axis rolling	000-127	0 -359 degree fixed X axis rolled	
	128-191	Clockwise rolling	
	192-255	Anticlockwise rolling	
CH8 Z axis rolling	000-127	0 -359 degree fixed Z axis rolled	
	128-191	Clockwise rolling	
	192-255	Anticlockwise rolling	
CH9 X axis mobile	000-127	128 different fixed position on X axis	
	128-191	Clockwise moving	
	192-255	Anticlockwise moving	
CH10 Y axis mobile	000-127	128 different fixed position on Y axis	
	128-191	Clockwise moving	
	192-255	Anticlockwise moving	

# Built-in pattern library & Product specification

## Built-in pattern library

DMX	Pattern	DMX	Pattern	DMX	Pattern	DMX	Pattern
000-007		064-071		128-135		128-135	
008-015		072-079		138-143		198-205	
016-023		080-087		144-151		206-213	
024-031		088-087		152-159		214-221	
032-039		096-103		160-167		222-229	
040-047		104-111		168-175		230-237	
048-055		112-119		176-181		238-245	
056-063		120-127		182-189		246-255	

## Product specification

Model	FIT-S(R) FIT-S(G) FIT-S(B)	FIT-S(RGY)	FIT-S(RBP)	FIT-S(GBC)	FIT-D(RG)	FIT-D(G) FIT-D(B)
Red LD 650nm	150mw	150mw	150mw		150mw	
Green DPSS 532nm	50mw	50mw		50mw	50mw	100mw
Bule LD 450nm	490mw		100mw	100mw		490mw
Laser level	Class 3B Laser					
Mess	160x145.5x80mm				200x145.5x80mm	
Weight	1.3kg	1.4kg			1.55kg	
Range	100-240V 50/60Hz					
Fuse	250V 1 A Slow Blow (20mm Glass)					
Consumption	15W				20W	
Channel Range	1-19	1-10			1-9	1-8
AUTO	One show AUTO	Four show AUTO			One show AUTO	
SOUND	One show SOUND	Four show SOUND			One show SOUND	