

Z 320

FULL-RANGE PASSIVE SPEAKER

Z series was created to deliver the power and professional sound quality into various indoor and outdoor spaces while keeping budget considerations in check.

Z 320 is a compact passive 12"+1" speaker, designed for both FOH sound and stage monitoring purposes. Equipped with angle-adjustable pole mount adapter and M10 mounting points, Z 320 is a versatile solution for many sound reinforcement applications.

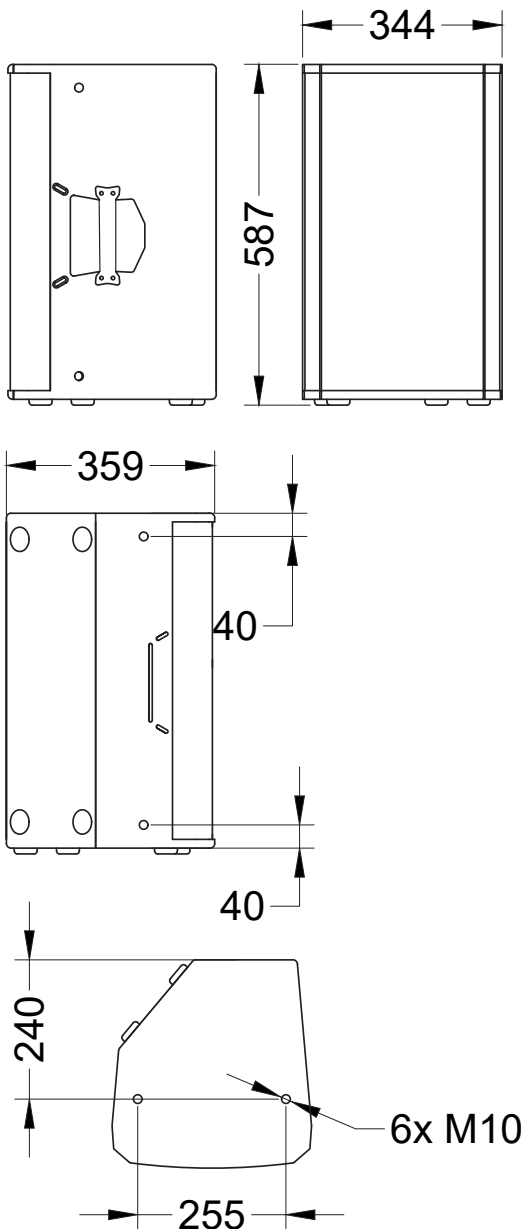

Main features:

- 350W nominal power
- 12" woofer with 2,5" voice coil
- 1" HF driver with 1,75" voice coil
- 130 dB Max SPL
- Adjustable pole mount adapter

Frequency Response (-10dB)	50 - 20000 Hz
Max SPL ¹	130 dB
Sensitivity (1W/1m)	96 dB
LF Driver	12", 2,5" VC
HF Driver	1", 1,75" VC
Nominal Coverage Angle (Horizontal x Vertical)	100 x 50 deg
Impedance	4 Ohm
Nominal power ²	350 W
Connectors	2x NeutrikSpeakon
Dimensions (WxHxD), mm	359x587x344 mm
Net weight, kg	16,6 kg
Shipping weight, kg	19,1 kg
Mounting	10x M10 mounting points, 35mm adjustable pole socket
Enclosure material	Plywood; wear-resistant paint
Grill	Steel grill, polymer protective net

¹ - peak value, calculated according to AES 2 - 2012

² - based on transducer power measured according to AES 2 - 2012

With dedication to constant improvement of the products, manufacturer may change the listed specifications without prior notice