

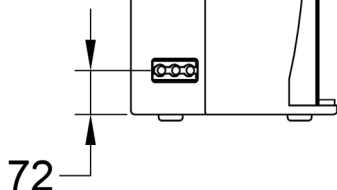

N 10

FULL-RANGE PASSIVE SPEAKER

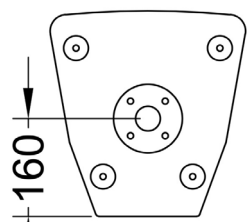
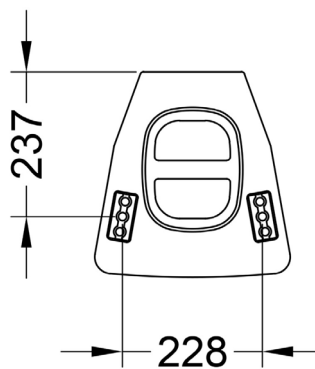
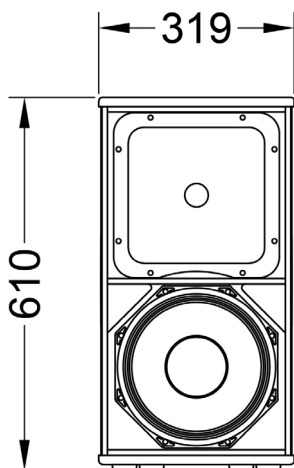

Main features:

- 600W nominal power
- 10" woofer with 3" voice coil
- 1,5" HF driver with 3" voice coil
- 131 dB Max SPL
- Pole mount adapter

Frequency Response (-10dB)	65 - 18000 Hz
Max SPL (peak)	131 dB (calculated)
Sensitivity (1W/1m)	97 dB
LF Transducer	10", 10N501
HF Transducer	1,5", N7150
Nominal coverage HxV	90° x 80°
Impedance	8 Ohm / 4 Ohm
Nominal power	600 W
Program power	1200 W
Peak power	2400 W

Connectors	2x Neutrik Speakon
Dimensions (WxHxD)	319x610x336 mm
Net weight	19 kg
Shipping weight	22 kg
Mounting	4x FlyTrack flying points Pole mount adapter
Enclosure materials	Plywood; wear-resistant paint
Grill	Steel grill, polymere protective net

Acoustical & Electrical data

Connections, physical data and exploitation